

INSTALLATION INSTRUCTIONS

ZPR68-10 SIX ZONE EIGHT SOURCE REMOTE CONTROL PREAMP

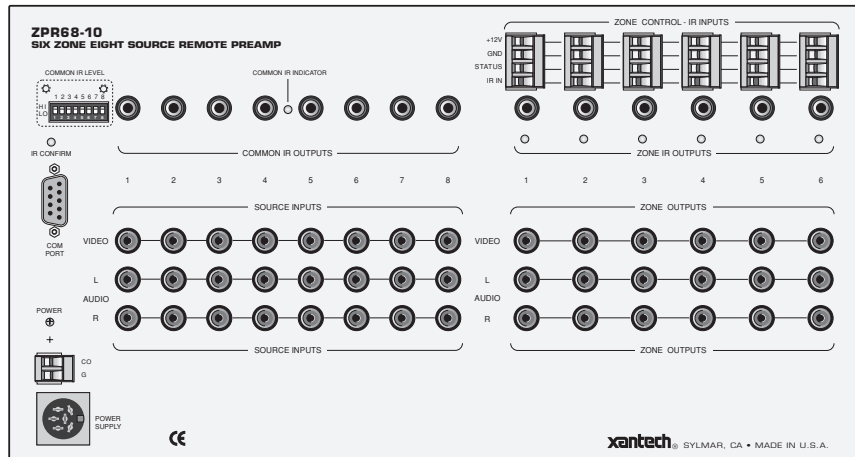

Fig.1 Model ZPR68-10

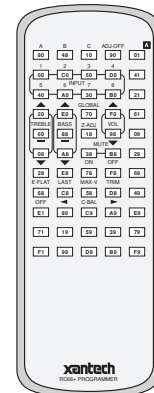

Fig. 2 Model RC68+
Handheld Programmer
(available separately)

GENERAL

The ZPR68-10 is an infrared remote controlled audio/video preamp capable of switching eight source inputs into six separate zone cards for multi-zone, multi-room operation.

- Low noise, low distortion, extended headroom design provides outstanding sonic performance in a highly versatile multi-room, multi-zone design.
- Each zone has separate Volume, Max. Volume, Mute, Balance, Bass and Treble functions, all installer adjustable. This permits an "EQ" profile to be created to best compliment the individual acoustics and preferences of each zone.
- Six IR IN control input ports, one for each zone, allows the connection of any Xantech keypad (except Model 598), IR receiver, controller, etc., for system control.
- Zone and common IR outputs permit IR control of zone and/or common components using Xantech 282/283/284/286 series mini emitters or 794/797 interface modules. Each emitter output at the common IR jacks is individually adjustable for high or low IR level.
- Eight separate line level inputs accommodate audio or audio/video sources such as CD players, AM/FM tuners, tape decks, satellite receivers, LD players, VCR's, etc.
- Input Level Matching. The input level for each audio source can be trimmed by the installer to prevent large volume differences when switching between sources.
- A COM PORT, using a female DB9 connector, allows full control and status operations with custom designed panels or computer programs. It is RS-232 data signal compatible. Refer to Application Advisory, Volume 2, Number 1, for details. This advisory is available on Xantech's web site at www.xantech.com and <http://www.xantech.com.engineer> for updates.
- A GLOBAL function allows the user to gang all zones for whole house control of POWER ON/OFF, SOURCE SELECTION, BASS, TREBLE, VOLUME and MUTE functions ("party mode"). GLOBAL operation can be prevented in any given zone by using the MUTE command.

- Zone STATUS and CO (common control) Outputs. An ON/OFF +12 V DC output is provided from each zone and one common to all zones. When a zone(s) is turned ON, these outputs can drive remote room ON/OFF STATUS indicators and/or drive the voltage sensing inputs (CI) of the PA1235 or controlled AC power strips for power management of zone amplifiers and common sources.
- RC68+ IR Remote/Programmer. Available separately, the RC68+ (or RC68) includes all the IR control codes necessary for the setup and operation of the ZPR68-10. Normally, the RC68+ commands would be "taught" into Xantech learning keypads, remotes, etc., for eventual use by the client.
- Zone expansion, in one zone increments, is provided by a separately available expansion module, Model EXP9, and zone PCB cards.

ZPR68-10 PANEL DESCRIPTIONS

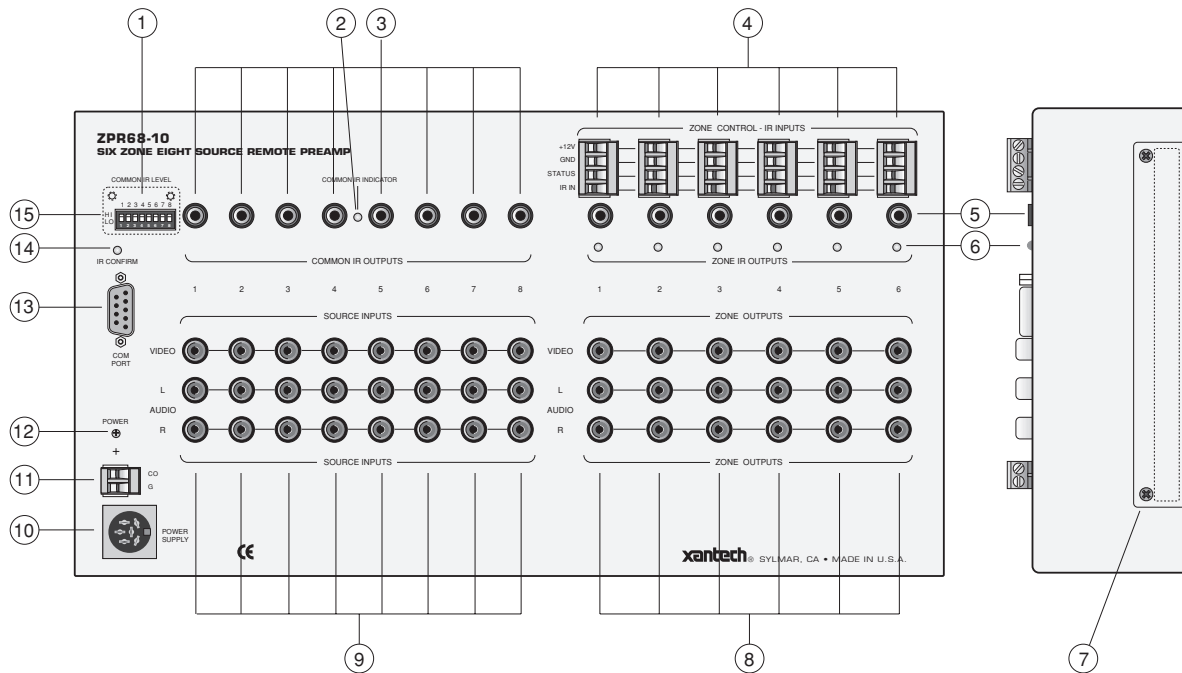

Fig. 3 ZPR68-10 Panel Features and Functions

1. **COMMON IR LEVEL** DIP Switches. These DIP switches set the output power level to HI or LO for emitters connected to the COMMON IR OUTPUT jacks. See item 4, under INSTALLATION, for details.
2. **COMMON IR INDICATOR** LED. This flashes when any IR commands are being sent to the COMMON IR OUTPUT jacks (even when emitters are not plugged in).
3. **COMMON IR OUTPUTS**. These eight 3.5mm mono mini jacks are for the connection of emitters to control source components that are common to all zones.
4. **ZONE CONTROL - IR INPUTS**. Each zone of the ZPR68-10 is individually controlled through these ports. Three of the four screw terminals on each plug-in connector are for connection, via the standard Xantech 3-wire bus, to any Xantech IR receiver, keypad (except Model 598), or controller. The remaining terminal, STATUS, provides a control output of +12 volts that turns on and off with the zone ON and OFF commands to drive status indicators and/or the voltage sensing ports of power amplifiers, such as the CI Inputs of a PA1235 or AC power strips. The connector markings are defined as follows: **+12 V, GND, STATUS** and **IR IN** (IR signal).
5. **ZONE IR OUTPUTS**. These six 3.5mm mono mini jacks are for the connection of emitters to control components dedicated to any zone.
6. **Zone IR Indicator** LED's. These six LED's, one for each zone, flash to indicate when a zone is receiving IR commands from any IR receiver, keypad, etc.

7. **ZONE EXPANSION PORT.** This port allows the ZPR68-10 to be linked with an EXP9 expansion module to provide up to 15 zones of operation. The EXP9 includes 9 slots, allowing zone XCARDS (PCB cards) to be added one by one in the field, or purchased already installed from the factory, for zones 7 through 15.
8. **ZONE OUTPUTS.** The ZONE OUTPUTS consist of six sets of audio/video RCA type jacks - one set for each zone. The **L** and **R AUDIO** jacks are connected to the appropriate Left & Right input jacks on a main power amplifier for the zone and the **VIDEO** jack to the composite Video input on a zone TV monitor or modulator. Any source connected to the SOURCE INPUTS can be switched to these ZONE OUTPUTS when the zone receives an RC68+ INPUT command at the ZONE CONTROL - IR INPUTS.
9. **SOURCE INPUTS.** The SOURCE INPUTS consist of eight sets of audio/video RCA type jacks - one set for each input. The **L** and **R AUDIO** jacks and the **VIDEO** jack are connected to the corresponding Left & Right audio and Video output jacks (where applicable) on up to eight source components (satellite receivers, LD players, VCR's, AM/FM tuners, CD changers, etc.).
10. **POWER SUPPLY Connector.** 6-Pin DIN jack permits connection of a high current multi-voltage AC power supply (included with each ZPR68-10).
11. **CO Terminals.** These two terminals provide a Control Output that goes high (+12 volts) when any zone is first turned ON and goes low (0 volts) when the last zone is turned OFF. Use this control voltage to drive the voltage sensing ports of power amplifiers, such as on the PA640 and the PA1235, and/or AC power strips to provide power on/off for the common source components and/or to drive a total system power on/off status indicator.
12. **POWER Indicator LED.** Indicates when power is applied to the ZPR68-10. It stays on continuously even when all zones are turned off (as long as AC power is applied to the plug-in power supply).
13. **COM PORT.** This DB9 female connector permits 2-way communications with the ZPR68-10 using custom designed control panels or computer programs. Port is RS-232 signal compatible, allowing bidirectional data interface for status readout of ZPR68-10 settings as well as control of operational functions.

COM PORT - RS232 Application Information. Use of this port requires proficiency in computer programming and hardware interfacing. Refer to application Advisory, Volume 2, Number 1, for basic communications protocol and hardware connection details. This advisory is available on Xantech's web site at www.xantech.com/products/alist/htm. For more detailed information, including latest updates, go to: <http://www.xantech.com.engineer> and make your selections from the list.

14. **IR CONFIRM LED.** Flashes when IR commands native to the ZPR68-10 are received & executed. Won't flash when non-ZPR68-10 IR commands are passed through to operate source components, etc.
15. **Cover Panel.** Remove this to access the 8 DIP switches for setting the power level of the COMMON IR OUTPUTS.
16. **Video Gain Adjustment Jumpers (internal).** The video gain of each zone on the ZPR68-10 can be set to two levels, by the use of an internal jumper. See **Fig. 4**. With the jumper on one pin only of PJ1, the video gain is unity (0 dB). When the jumper is inserted onto both pins of PJ1, the video gain is increased by +3 dB. You should use the +3 dB position only if you notice a reduction in picture contrast and brightness when running long cable lengths (usually in excess of 150 feet). Since the majority of applications will not require additional gain, all

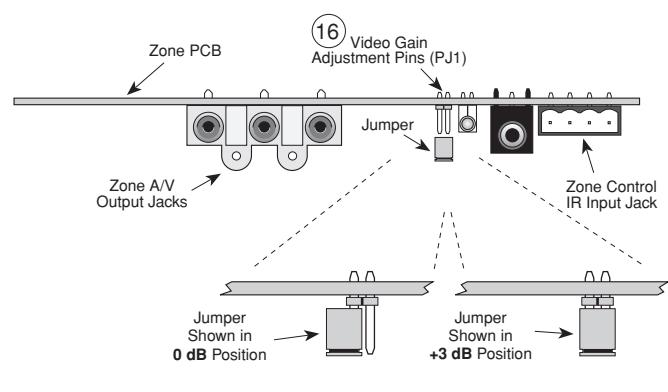

Fig. 4 Video Gain Adjustment - Jumper Locations

ZPR68-10's are shipped from the factory with the jumper installed on one pin only (0 dB).

To gain access to the jumpers you will need to remove the top cover as follows.

- a) Remove power supply plug from the Power Supply jack on the ZPR68-10 (if currently plugged in).
- b) Remove the five (5) screws on each end of the top cover.
- c) Remove the six (6) screws just under the six Video jacks of the Zone Outputs.
- d) Remove one (1) screw just below the Power LED.
- e) Remove the two (2) hex nut screws from the COM PORT.
- f) Carefully lift the cover off.
- g) When reassembling, be sure to carefully align the holes in the top cover with the jacks and the LEDs on all the PCB's before pressing it down into place and replacing the screws.

RC68+ PROGRAMMER / REMOTE CONTROL

The RC68+ (and the RC68) programmer, available separately, contains all the commands necessary to set up and operate the ZPR68-10.

- In addition, you will need it to program the universal learning devices actually used by the client, such as the Xantech URC-1 learning remote, the Xantech Smart Pads, the 590 Programmable Controller, the 710 Fone Link, etc.
- While the RC68+ will operate as a separate remote control, it is highly recommended it not be given to the final user for the following reasons:
- First, since it includes special setup codes, the user may inadvertently alter the installer configurations.
- Also, since the user will require IR commands from other brands of equipment to control the total system, in addition to those for the ZPR68-10, all commands should be consolidated into one learning device, for ease of use.

RC68 BUTTON DESCRIPTIONS

1. **IR Emitter Lens**
2. **ADJ-OFF** button. Provides instant turn-off of the TRIM and Z-ADJ modes. TRIM and Z-ADJ will also turn off automatically 10 seconds after the last button press.
3. **INPUT** Select buttons. Press these to select up to 8 audio/video sources connected to the ZPR68-10. Also, pressing any INPUT button turns the addressed zone ON.
4. **GLOBAL** button. After pressing this button (within 5 seconds) all subsequent commands (i.e. INPUT, VOLUME, MUTE, BASS, and TREBLE) will be applied to all zones, in addition to the addressed zone, from any zone location.
5. **VOLUME** Up/Down buttons. When pressed, volume will increase and decrease in 2 dB steps between 0 dB and -80 dB. When buttons are held down, the vol-

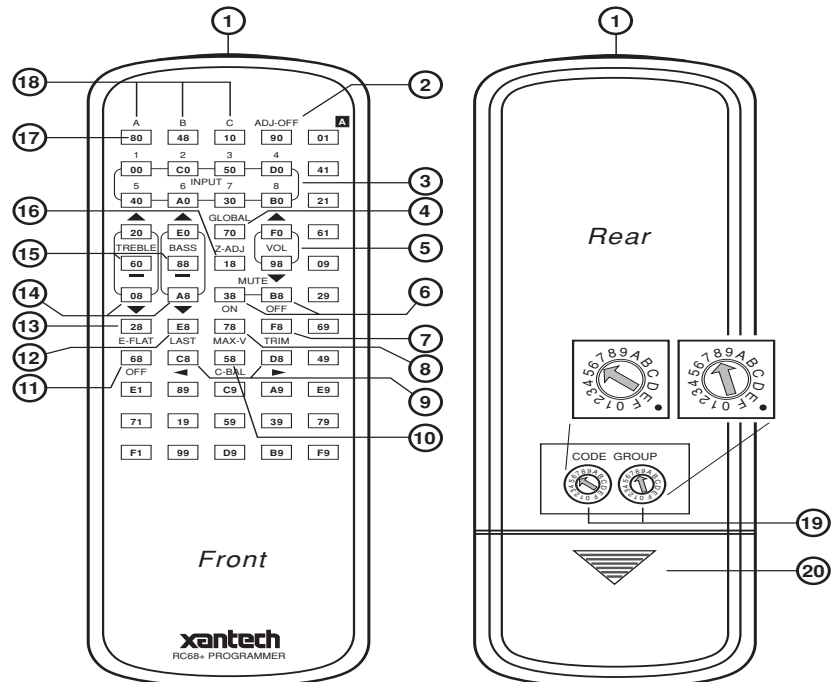

Fig. 5 RC68 Functions

ume level will ramp continuously. When a zone is turned OFF, then ON again, or if power is interrupted, the volume will return to its last setting.

6. **MUTE ON / OFF** buttons. Separate On / Off buttons give positive mute commands without knowing what the status is. This is very helpful in a remote room when all adjustments are made "blind" without any visual aids for status.

NOTE: Mute is released (audio on) when a VOLUME, INPUT, BALANCE, BASS or TREBLE command is sent, in addition to MUTE OFF.

7. **TRIM** button. Activates the Input Level Trim mode. This allows level trimming of each input on the ZPR68-10 so that all sources will sound equally loud when switching from one source to another (see ADJUSTING INPUT LEVEL TRIM procedure). The TRIM mode will turn off automatically 10 seconds after the last button is pressed, or, it can be instantly defeated by pressing the ADJ-OFF button.
8. **MAX-V** button. Saves the maximum desired volume level for the zone when in the Z-ADJ mode (see ZONE ADJUSTMENTS procedure).
9. **BALANCE** buttons. When the BALANCE "arrow" buttons are pressed, the audio output will move to the left or right in 2 dB steps with each left or right press. (**NOTE:** No change will occur if they are held down continuously).
10. **Balance "Center"** button. This button, when pressed (identified by a "—" mark), will instantly return the balance to the center position from any previous setting.
11. **OFF** button. Turns the zone OFF. The ZPR68-10, however, remains in "Standby" mode, ready for zone turn-ON when any INPUT button is pressed.
12. **LAST** button. Returns to the last adjusted values when comparing customized tone and balance settings to electrical flat (E-FLAT). Refer to ZONE ADJUSTMENTS procedure.
13. **E-FLAT** button. Switches the tone settings to electrical flat (flat frequency response) and the balance to center from customized settings. In conjunction with the LAST button, it allows instant audible comparisons during setup procedures. Refer to ZONE ADJUSTMENTS procedure.
14. **TREBLE & BASS** control buttons. When the "arrow" buttons are pressed, the treble and bass response can be increased or decreased from 0 dB to ± 12 dB in 2 dB steps with each up or down press. (**NOTE:** No change will occur if they are held down continuously).
Use these controls to "EQ" (equalize) the sound for each zone's acoustic differences during the "Z-ADJ" settings. The values arrived at become the "N-Flat" values ("EQ'd" values) for the user.
15. **Treble & Bass "N-Flat"** buttons. These buttons, when pressed (identified by a "—" mark), will instantly return the treble and bass to the "N-Flat" values (nominal or EQ'd" values) from any previous settings the user may have used.
16. **Z-ADJ** button. Activates the ZONE ADJUSTMENTS mode, allowing customized bass, treble, balance and max. level settings for each individual zone. Z-ADJ will turn off automatically 10 seconds after the last button press, or, it can be instantly defeated by pressing the ADJ-OFF button. Refer to ZONE ADJUSTMENTS procedure.
17. **Code Group Numbers.** Each button face on the RC68+ is marked with a Code Group Number identifying a total of 55 different IR Remote Control Code Groups.
These code groups allow Xantech products that use RC68+ codes, to have a different code group assigned to each one. This prevents mutual interaction when both are used on the same IR bus in an IR system. This also permits the installer to change the code group in the field if two or more of the same Xantech model are used on the same IR bus.
Refer to the INSTALLER INSTRUCTIONS that come with the RC68+ for Code Group Setting Procedures.

NOTES:

- a) Each zone of the ZPR68-10 can be set to its own individual Group Code. This may be useful when the system requirements so dictate.
 - b) The Code Group Number assigned and preset at the factory for each zone of the ZPR68-10 is **68**.
 - c) Since other Xantech IR controlled models are assigned and preset at the factory to different Code Groups, it is unlikely that you will ever need to change the Code Group on the zones of the ZPR68-10 away from the factory preset number of **68**.
18. **A, B, C** buttons. These operate special control functions on other Xantech IR controlled products.
19. **Code Group Setting Switches**. These rotary switches are for setting and selecting the specific IR Remote Control Code Groups. **These must be set to 68 to work with the ZPR68-10!**
- Refer to the INSTALLER INSTRUCTIONS that come with the RC68+ for Code Group Setting Procedures.
20. **Battery Compartment**. Holds two 1.5V "AA" batteries that power the RC68+. Use Alkaline batteries for longest life. Slide cover in the direction of the arrow for removal.

INSTALLATION

Fig. 6 shows a typical installation of a ZPR68-10 utilizing all 8 source inputs and all 6 zone outputs.

- A variety of Xantech IR receivers and keypads control the zones and the source equipment.
- The **STATUS** terminal on each zone provides zone ON/OFF indication on their respective IR receivers and keypads.
- Two Xantech PA640 Power Amplifiers drive the stereo pairs of speakers in each of the six zones.
- The common **CO** terminal provides AC power ON/OFF management for the PA640's and for the common sources through GATEKEEP-IR™.

Note: All source components in this typical system must have their ON/OFF function controlled by IR. See the GATEKEEP-IR Installation Instructions for all GATEKEEP-IR programming procedures.

CONNECTION PROCEDURE

The following procedure is based on **Fig. 6**, and assumes that all rooms in the house, where remote controlled A/V signals are desired, have been pre-wired with home runs of 4-conductor cable, coaxial cable and speaker wires. In addition, all IR receivers, keypads and speakers have been connected in each room, and the system is ready for installation of the ZPR68-10 and other components.

CAUTION: Be sure no power is applied to any of the components until all connections are made.

1. Make connections from each of the zone 4-conductor cables to the **ZONE CONTROL - IR INPUTS** terminals.

*Note that in **Fig. 6** only zones 2 & 3 have IR receivers - the rest are keypads. This assumes the use of learning remotes capable of macro (sequence) programming for GATEKEEP-IR functions.*

SPECIAL NOTE: When using long lengths (>50 feet) of inter-room shielded cable, it may be necessary to connect a 470 Ohm 1/8 Watt resistor between Input (signal) and Gnd at the IR input terminals of the ZPR68-10. The resistor discharges the cable capacitance more quickly, allowing IR codes of high bit rates to pass without data loss for consistent command executions. See **Fig. 7**.

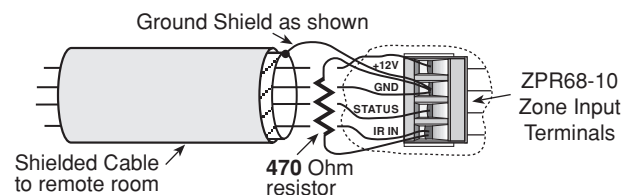
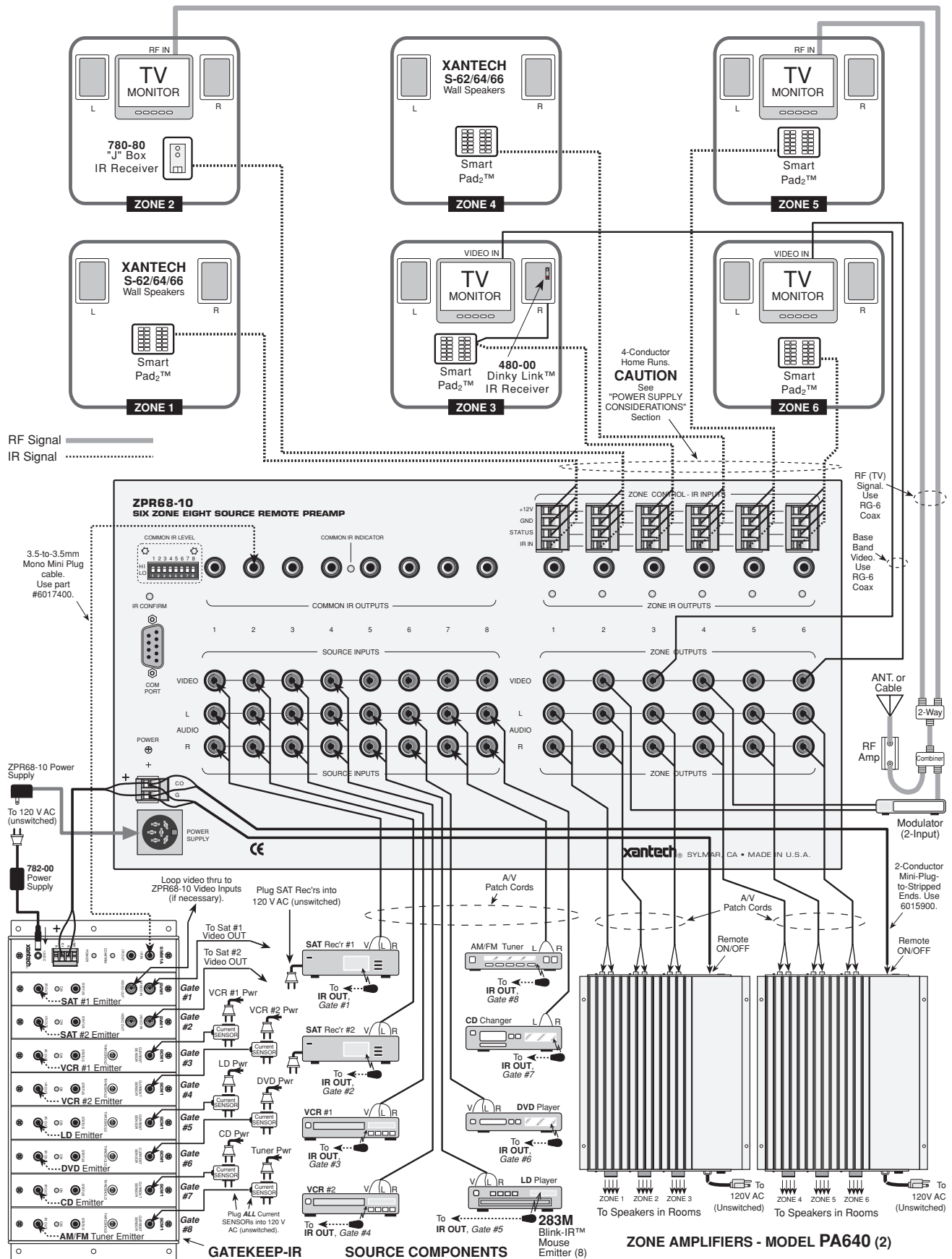

Fig. 7 Using 470 Ω Capacitance Discharge Resistor

Fig. 6 Typical System



Amplifiers & Preamplifiers

2. Connect the audio and video Output jacks on each of the audio/video source components to the **SOURCE INPUTS** jacks on the ZPR68-10.

Use high quality audio and video RCA-type patch cords.

3. Place a model 283M Blink-IR Emitter on the IR sensor window of each source component, and plug them into the IR OUT on the appropriate GATEKEEP-IR modules. Connect one of the COMMON IR OUTPUTS on the ZPR68-10 to the IR IN of the GMM1A module on the GATEKEEP-IR.
4. In cases where you may connect emitters directly to the COMMON IR OUTPUTS, you may need to change the **COMMON IR LEVEL** DIP switch settings (item #1). To do so, remove Cover Panel (item #15). All are set to the **LO** position at factory.

*Consider the following factors when choosing **High** or **Low** power settings for the source emitters:*

- a) In the majority of cases, when you mount an emitter on the IR sensor window of the controlled device, you would use the **Low** power mode. This prevents overload of high gain sensor circuits, for best operation.
 - b) The **High** power mode may be used when you mount the high output 282M emitters on an adjacent shelf or door a short distance from the unit's sensor. Another instance is when you place an emitter inside the device, but cannot place it close to the IR sensor. In such cases, you may need the high power setting to blast through printed circuit boards or around chassis structures, etc. In addition, when using the lower output 283M and 286M Blink IR's, you may need the high power mode for some devices that have less sensitive IR sensors.
5. Connect the common **CO** and **G** terminals (item #11, located just under the POWER indicator) to the **REMOTE ON/OFF** inputs on the two PA640 Power Amplifiers and to the **+** and **-** terminals of the GMM1A Module of the GATEKEEP-IR.

*You may use two of the Xantech part #6015900 five foot 2-conductor cables (3.5mm mini plug on one end and stripped tinned ends on the other) for connection to the PA640's. Connect the white-striped side to **CO** and the other to **G**.*

6. Connect the **AUDIO L** and **R ZONE OUTPUT** jacks on the ZPR68-10 to the **CH1**, **CH2**, etc., **LINE INPUT** jacks on each of the PA640 Power Amplifiers.

*Use high quality audio RCA type patch cords. You may connect the **L** channels from the **ZONE OUTPUTS** on the ZPR68-10 to **CH1**, **CH3** & **CH5**, respectively, on the PA640 's and the **R** channels to **CH2**, **CH4** & **CH6**. Be sure to follow this through when connecting the speaker leads so that the **L** and **R** channels are correctly connected to the Left and Right speakers in the rooms.*

7. Connect the **VIDEO** outputs from Zones 3 and 6 to a Video Input on the TV monitors in zone rooms 3 and 6.

*Use RG-6 coaxial cable with RCA type phono plugs on each end. You may need to adjust the Video Gain on the zone cards if you have coaxial cable runs greater than 150 feet. See **Fig. 4** for details.*

8. Connect the **VIDEO** outputs from Zones 2 and 4 to the Video Inputs of a 2-Input Modulator.

Use high quality RCA type video patch cords.

9. Make the necessary connections of the Modulator to the Combiner, Cable System, Splitter, etc.

*Use RG-6 coaxial cable with "F" connectors on each end to connect each device, including the coaxial cables going to the **RF IN** on the room TV's in Zones 2 and 5.*

10. Connect the speaker leads from each Zone room to the corresponding **SPEAKERS** terminals on the PA640 Power Amplifiers.

*Be sure to observe correct **L** and **R** channel assignment and speaker phasing (**+** and **-**). Use 14 gauge speaker wire for lengths up to 200 feet.*

11. Plug the Power Supply (included with the ZPR68-10) into the DIN jack marked **POWER SUPPLY** (item #10).

12. Plug the power cords from 6 of the Source Components into the Current Sensors of the GCM1 GATEKEEP-IR modules. In turn, plug the Current Sensor units into unswitched 120 VAC outlets. Also, plug the two SAT receivers into 120 VAC unswitched AC outlets. *In this particular setup, the SAT receivers use the GVM1 video sensing modules rather than current sensing. Refer to the GATEKEEP-IR Installation Instructions for all GATEKEEP-IR programming procedures.*
13. Set all power switches on the PA640's to the **OFF MANUAL (REMOTE ON/OFF)** position.
14. Plug all remaining power cords into unswitched 120V AC outlets.

CAUTION: When configuring your own particular system, be sure to take into consideration the power demands of all keypads, IR receivers, etc. See **POWER SUPPLY CONSIDERATIONS** on the following page. When you have done this and completed all connections, the ZPR68-10 system would then be ready for the **Setup** and **Operating Procedures**.

POWER SUPPLY CONSIDERATIONS

The total current available from the **+12V**, the **STATUS** and **CO** (control out) terminals on the ZPR68-10 to power keypads, infrared receivers, switching devices, etc., is **1.8 A**. In addition, each of the zone **STATUS** terminals and the **CO** terminal have a current limit of **90 mA** each max. These currents are enough to power all but the most unusual installations. **However, if you have a system where the total current demand does exceed 1.8 A, then an external power supply(s) must be used to power the extra devices to prevent overheating and shutdown of the ZPR68-10.**

The following table shows the current required by Xantech devices typically used with the ZPR68-10 in zoned-controlled multi-room systems:

<u>DEVICE</u>	<u>CURRENT DEMAND</u>
IR Receiver Models	
291-10, 480 series, 490/495 series, 780-10	10 mA
291P, 291-455, 780P, 780-455 (hi-frequency types)	15 mA
291-80, 480-80, 780-80 (CFL types)	20 mA
780-80 Status LED	10 mA
Keypad Models	
730 SmartPad	65 mA
SmartPad ₂ , SmartPad ₃ , WPK	85 mA
SmartPad _{2&3} Status line (PM110, LM110, & WPK series)	5 mA
Models With Control Inputs	
PA640 6 Channel Power Amplifier	11 mA
PA1235, 12 Channel Power Amplifier	16 mA
599 Pulsed Switching Module	11 mA
CC12 and SR21 Relay Modules	1 mA

Procedure

Add up the current demands for the devices used in the system. If the total current exceeds **1.8 A**, it is then necessary to use a 782-00 power supply to separately power the **V** or **+12V** terminals of the additional devices that cause the over-current condition. See typical connection diagram, **Fig. 7**.

Note: The **STATUS** or **CI** (Control Inputs) of the devices must remain connected to the respective zone **STATUS** and common **CO** terminals on the ZPR68-10, where used. Also, if you exceed **90 mA** on any of these terminals, use a Xantech **CC12** Remote Relay Module to reduce the current demand. Refer to the CC12 Installation Instructions, Fig. 6, for details.

Example 1

Four Smart Pad₂'s (with Status), five 780-80's (with Status), two PA640's and one 599 Pulsed Switching Module are used. Add up the currents: $(4 \times 90 \text{ mA}) + (5 \times 30 \text{ mA}) + (2 \times 11 \text{ mA}) + (1 \times 11 \text{ mA}) = 543 \text{ mA}$ total. This is well within the **1.8 A** (1800 mA) limit. Therefore, no external power supply is needed.

Example 2

24 Smart Pad₂'s (4 per zone, with Status), twelve 780-80's (2 per zone, with Status), two PA640's and one 599 Pulsed Switching Module are used. Add up the currents: $(24 \times 90 \text{ mA}) + (12 \times 30 \text{ mA}) + (2 \times 11 \text{ mA}) + (1 \times 11 \text{ mA}) = 2553 \text{ mA}$ total current. This exceeds the **1.8 A** limit by 753 mA. Therefore, a 782-00 external power supply is needed to power the extra Smart Pad₂'s and IR receivers that cause the **1.8 A** limit to be exceeded. In this case, you would have to power seven Smart Pad₂'s and five 780-80 IR Receivers externally (780 mA) to ease the load sufficiently.

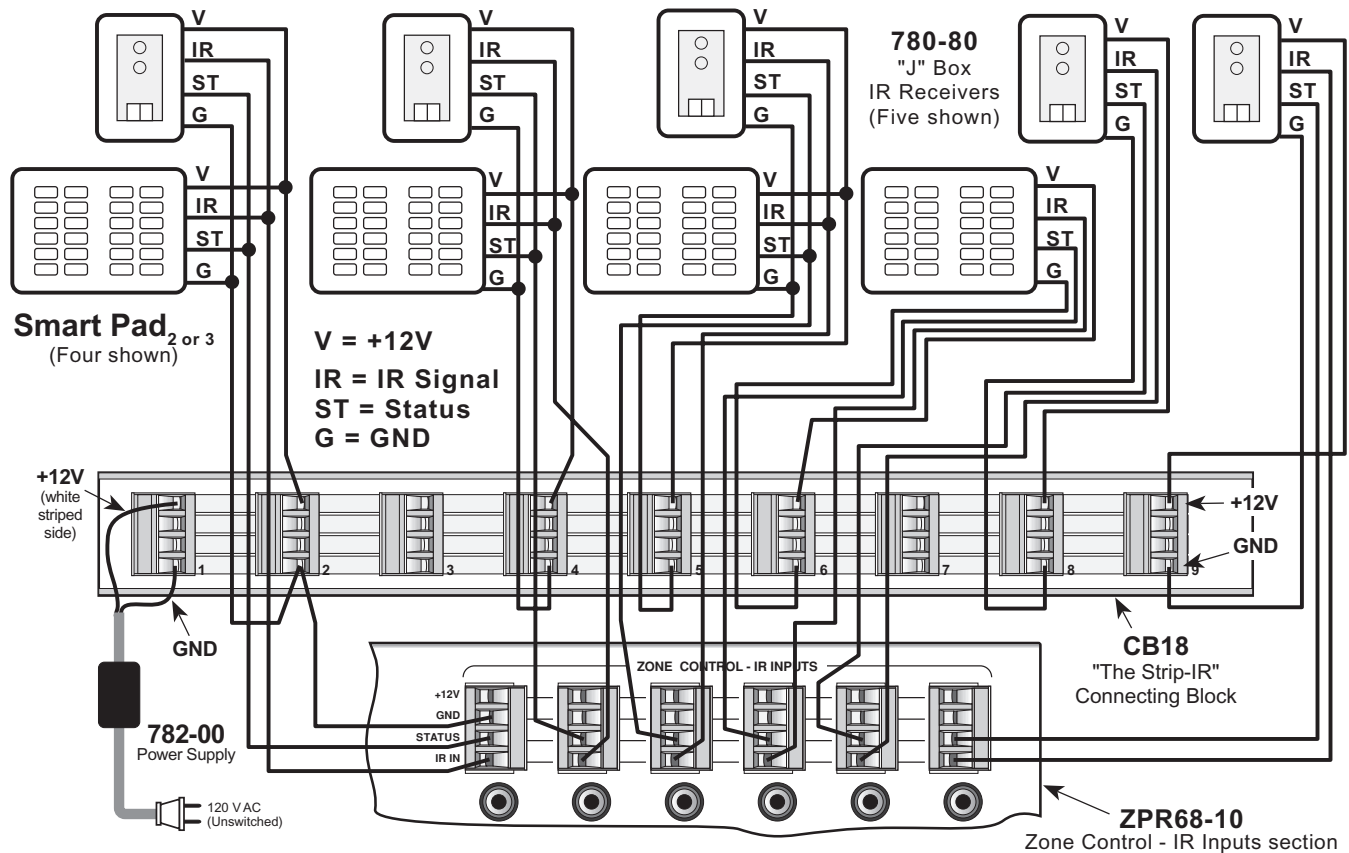

Fig. 7 Using a CB18 to provide a +12V DC rail (if needed) to externally power extra keypads and IR receivers to prevent overload of the internal power supply of the ZPR68-10.

Fig. 7 illustrates how you can do this by using a CB18 "Strip-IR" Parallel Connecting Block to provide a separate +12V DC rail. This powers the additional IR receivers and keypads independent of the +12V of the ZPR68-10.

NOTE: The 782-00 Power Supply has a capacity of 1000 mA. If you have a system that is so extensive that the total current exceeds the **1.8 A** limit of the ZPR68-10 by more than 1000 mA, use two 782-00's connected so that **two separate +12V DC rails** are created. Connect two groups of the extra devices so that the total excess load is shared equally between the two 782-00's.

CAUTION: To prevent current "hogging" and power supply shutdown, never connect a 782-00 in parallel with the +12V terminal of the ZPR68-10 or in parallel with another 782-00!

ZPR68-10 BASIC SETUP AND OPERATING PROCEDURES

The following procedures assume the prior connection of all eight SOURCE INPUTS and two PA640's in a fully wired six-zone system similar to that shown in **Fig.6**.

- Each zone IR IN has a Xantech Key Pad and/or Xantech IR Receiver connected.
- For AC power management, six of the common sources are current sensed and two are video sensed by the Gatekeep-IR™ for ON/OFF status. All are switched ON and OFF by sequenced commands from the SmartPads and programmable remotes.
- The Common CO (Control Out) port on the ZPR68-110 controls System Power OFF status for the GATEKEEP-IR and also turns the PA640's ON and OFF via their Remote ON/OFF inputs.
- All source components in this typical system must have their ON/OFF function controlled by IR.
- See the GATEKEEP-IR Installation Instructions for all GATEKEEP-IR programming procedures.

SETUP PROCEDURES

Turning The System ON

1. Press an **INPUT** button (1 through 8) on the RC68+ hand held Remote Programmer while aiming at an IR receiver in any zone.
Note: All setup instructions in this procedure assume the use of the RC68+ or RC68 hand held Remote Programmer.
2. Press each INPUT button and activate each source. *(Make sure each is playing).*
3. Adjust VOLUME buttons to a comfortable listening level.

Adjusting Input Level TRIM

This procedure allows all sources to sound equally loud when switching from one to another.

1. Select the input that has the lowest apparent volume level *(from any zone)*.
2. Press **TRIM** button. *(This activates the TRIM mode)*.
Note: TRIM mode allows 10 seconds after each button press for the next command to be executed. If you exceed 10 seconds, simply press TRIM again. You can verify whether you are still in the TRIM mode by pressing the MUTE ON button. If the sound mutes, you are not in the TRIM mode.
3. Select any other input that sounds louder.
4. Adjust **VOLUME** buttons until the apparent loudness is the same as step 1.
5. Select another input that sounds louder.
6. Adjust **VOLUME** buttons again until the apparent loudness is the same as step 1.
7. Repeat this procedure for each remaining input.
8. Verify your settings by selecting each input again, making adjustments as necessary.
9. When the last input is adjusted, press one more input (the same or any other), to **save** the last setting.
10. Press the **ADJ-OFF** (Adjustments Off) button to drop out of the TRIM mode. *(TRIM mode will drop out automatically if you wait more than 10 seconds).*

The **TRIM** settings are now saved for all zones, completing the procedure.

Zone Adjustments

These adjustments allow customized bass, treble, balance and maximum level settings to best compliment the acoustics and preferences for each zone.

1. Go to desired zone.
2. Select desired **INPUT** (source).
3. Press **Z-ADJ** button. *(This activates the Zone Adjustments mode).*

Note: Z-ADJ mode allows 10 seconds after each button press for the next command to be executed.

If you exceed 10 seconds, simply press Z-ADJ again. You can verify whether you are still in the Z-ADJ mode by pressing the MUTE ON button. If the sound mutes, you are not in the Z-ADJ mode.

4. While listening to the program material, set **BASS**, **TREBLE** and **BALANCE** as desired.
You may instantly compare your bass & treble settings to electrical flat by pressing the "E-FLAT" button. Return to your last adjusted settings by pressing the "LAST" button. Make further adjustments and repeat this procedure as often as necessary to arrive at a pleasing tonal balance for the zone.
5. Adjust **VOLUME** buttons for the maximum volume desired for the zone.
6. Press **MAX-V** button to save maximum volume.
7. Press the **ADJ-OFF** button to drop out of the Z-ADJ mode. (*Z-ADJ mode will drop out automatically if you wait more than 10 seconds*).

The **Z-ADJ** settings are now saved, completing the procedure.

Note: *In zones using only keypads, it will be necessary to temporarily connect a Xantech IR receiver to make the zone adjustment settings.*

8. Repeat steps 1 through 6 for each zone.

Note: *After the settings are saved, you can still compare your bass, treble and balance settings with electrical flat by alternately pressing the "E-FLAT" and "LAST" buttons. When finished comparing, be sure to press the "LAST" button so that the Z-ADJ settings are in effect for the user.*

PLEASE NOTE: In zones using only keypads, it will be necessary to **temporarily connect a Xantech IR receiver to perform TRIM and Z-ADJ setup procedures.**

When the setup procedures are complete, the next step is to program the Xantech SmartPads and/or learning remotes (such as Xantech's URC's), with the needed GATEKEEP-IR, ZPR68-10 and the source component commands for system operation from any zone.

OPERATING INSTRUCTIONS

These instructions assume a fully connected system similar to **Fig. 6** and the completion of all setup procedures. It also assumes that the installer has "taught" all needed or desired IR commands from the RC68+ Programmer and from the remotes of the source components into learning remote controls or key pads. These instructions may serve as a reference for the installer when preparing a customized instruction set for the end user.

Zone Operations

1. Press an **INPUT** button for the desired source from any zone.
This turns the zone ON and applies power to the zone amplifiers and all source components.
2. Operate the source component with the appropriate IR commands (TUNER UP/DN, CD PLAY, etc.)
3. Adjust **VOLUME** buttons to desired level.
4. Adjust **BASS**, **TREBLE** and **BALANCE** for personal preference. (*If made available to the user*).
Note: *You may return to the Z-ADJ values for BASS, TREBLE and BALANCE at any time by pressing the "-" button on each one ("N-FLAT" settings).*
5. Press **MUTE ON** to mute the sound for that zone. (*The video signal will continue to play*).
6. To un-mute the sound, press **MUTE OFF**. (*Mute can also be released by pressing a volume or any input [source] button.*)
7. Press **OFF** button to turn the zone OFF. (*The video signal will continue to play*).

Note: *When the zone is turned back on, the volume level last listened to will be restored.*

Global Operations

1. Press **GLOBAL** from any zone location.

Note: All GLOBAL commands must be executed within 5 seconds of each other. When 5 seconds

elapse, GLOBAL is cancelled and the system reverts to Zone operation. **If you run out of time, simply press GLOBAL again.**

2. Press desired **INPUT** button (source).

This turns all zones ON together and applies power to all zone amplifiers and to all source components. The selected source will now play in all zones at the volume level last listened to in each zone.

3. Operate the source component with the appropriate IR commands (TUNER UP/DN, CD PLAY, etc.)
4. Adjust **VOLUME** buttons to desired level.

Note: If MUTE ON has been previously activated in any zone, it will not be overridden by the GLOBAL command. This prevents zone occupants from being disturbed by Global commands, when desired.

5. Adjust **BASS** and **TREBLE** for personal preference. (If these are made available to the user).

Note: You may return to the Z-ADJ values for BASS and TREBLE at any time by pressing the “-” buttons (“N-FLAT” settings).

6. To mute all zones simultaneously, press **GLOBAL**, then **MUTE ON**.

(Mute can also be released by pressing a volume or any input [source] button.)

7. To un-mute all zones simultaneously, press **GLOBAL**, then **MUTE OFF**.

8. To turn all zones OFF simultaneously, press **GLOBAL**, then **OFF**.

(The video signal will continue to play).

REMEMBER, the zone command mode lasts only 5 seconds after the last key is pressed. Anytime you want to make a subsequent global adjustment, such as volume (as when in a whole house party mode), you must always press GLOBAL first.

AC Power Interruptions

If an AC power line failure occurs, proceed as follows after power is restored:

1. Press an **INPUT** (source) button to turn any zone ON.
2. Adjust **VOLUME** and other functions as outlined under **Zone Operations**.

Note 1: On older versions of the ZPR68-10, the initial volume at turn-on will be a low, factory set, default level. It will NOT return to the volume level last listened to. All other adjustments will remain as previously set.

Note 2: Latest versions of the ZPR68-10 (beginning with serial #11183) **WILL** return automatically to the ON condition after a power interruption and will play at the volume level last listened to.

TROUBLESHOOTING

If you encounter problems with the setup or operation of the ZPR68-10, review each of the following items and take corrective action as described. If problems persist, contact Xantech Technical Support.

1. **I have connected sources, zone amplifiers, IR receivers or keypads and the power supply. The POWER LED comes on but the ZPR68-10 does not respond to any IR commands from the RC68+ Handheld Programmer.**
 - a) The most frequent reason for this problem is that the RC68+ is not set to the correct IR Code Group. It must be set to **68** to work with the ZPR68-10 (unless you have intentionally changed the ZPR68-10 to a different Code Group number). Refer to the INSTALLER INSTRUCTIONS that come with the RC68+ for Code Group Setting Procedures.
 - b) IR noise may be entering one or more of the IR receivers in the zones. This would interfere with the proper recognition of the IR codes. Take steps to remove the IR noise or use Xantech IR Receivers with high noise immunity (the CFL types).

- c) Check to be sure the source components, amplifiers and speakers are connected and operating correctly. Connect a source directly to one of the power amplifiers (bypassing the ZPR68-10 completely) to verify operation of these components.

2. Most of the zones operate correctly, but one or two do not respond to the RC68 commands.

- a) You may have inadvertently changed the IR Group Code on one or two of the zones during setup procedures, or it was set incorrectly at the factory. Using the Code Group Setting Procedures that come with the RC68, set the Code Group to **68** on the inoperative zone(s).
- b) IR noise may be interfering with a particular zone. To correct, refer to 1. b) above.

3. Commands (such as Mute, Volume, etc.) sent to one zone will sometimes operate another zone as well (IR signal cross talk).

This may occur if you are running the IR bus leads of IR receivers or keypads for more than one zone through a common shielded cable to the ZPR68-10 Zone Control IR-Inputs. Capacitive coupling between the signal conductors in the multiconductor shielded cable may be causing the cross talk.

- a) To correct this, you will need to run completely separate cables (home runs) for each room.
- b) If it is not possible to run completely separate cables, or the source of the cross talk cannot be determined, you could change the IR Code Group of one or more of the zones to a different number. The drawback to this solution is that you would need dedicated learning remotes (if used) for the rooms having the different IR Code Groups.

4. I have two (or more) zone dedicated same-brand CD players (or other source components). However, when I send commands to one of them, it operates the other(s) in the other zone(s) as well. (Zone-to-zone IR cross talk).

The IR output from the emitters connected to the Common IR Outputs (attached to the common components, e.g. tape, VCR, tuner, etc.), may be radiating into the IR sensors of the zone dedicated source components, if such components are placed in close proximity to each other. Cross-talk can also occur if there is close proximity between the zone dedicated source components themselves.

- a) Troubleshoot by unplugging the emitters one at a time. If you are using 282 emitters, be sure to use the opaque shells and window masks that come packaged with them. This should stop stray IR signals from bleeding over into the zones that have dedicated source components.
- b) Use 283 emitters instead of the 282's. These have less output than the 282's and have been found to be more effective even though opaque shells and window masks are not used with them.

5. The volume UP/DOWN commands must be repeatedly pressed to effect large changes in volume level (will not ramp continuously).

- a) IR noise may be entering one or more of the IR receivers in the zones. To correct, refer to 1. b) on previous page.
- b) If you have programmed Smartpad_{2 or 3}'s with Dragon Drop-IR, download the ZPR68-10 IR codes from the Xantech web page and use volume commands from this palette file instead. These commands, when transferred to the Smartpad_{2 or 3}'s, repeat as full command frame codes and will work better in the presence of random IR noise.

6. It seems that Global commands do not always affect all zones.

You may have allowed more than 5 seconds to elapse between commands after Global was initiated.

- a) Be sure to execute the desired commands within 5 seconds of each other after the GLOBAL button is pressed.
- b) A good rule of thumb is to press GLOBAL each time just before executing global commands rather than trying to guess whether 5 seconds has elapsed or not.

7. **When I select input #1, no sound plays through. Inputs #2 through #8 work just fine.**
 - a) Make sure the source plugged into input #1 is actually working by trying it on one of the other "working" inputs.
 - b) If the source is proved to be OK, plug it into #1.
 - c) Connect an IR receiver to a zone IR input.
 - d) With the source playing, aim the RC68 at the IR receiver and press input #1 and then the **TRIM** button.
 - e) Press the **VOLUME** up button to achieve max. volume, then down a step or two.
 - f) Press input #2, then **ADJ-OFF**. Input #1 should now play OK.
 - g) Go to **SETUP PROCEDURES** and redo the Input Level **TRIM** adjustments.
8. **I have a keypad (or an IR receiver) connected to one of the zones through a long length of multiconductor shielded cable (sometimes even with very long lengths of unshielded cable). Commands for some of the components work just fine, but others do not work at all or are very intermittent.**
 - a) Connect a 470 Ohm 1/8 Watt resistor between **INPUT** and **GND** on each of the offending zones. Refer to **Fig. 7** under **INSTALLATION** section for details.

The capacitance of the shielded cable prevents high bit rate commands from passing through unaltered. The resistor effectively discharges the capacitance, correcting the condition.

See next page for ZPR68-10 Block Diagram

SPECIFICATIONS

AUDIO (ea. channel)

Gain (@ max VC*):	Unity
Input Overload:	> 4 V RMS (@ max VC*)
Input Impedance:	> 40 k Ohms
Output Impedance:	470 Ohms
Signal to Noise:	96 dB (re 2V out)
THD: (VC -10 dB)	0.01% at 2V input level
Frequency Response (± 3 dB):	5 Hz to 70 kHz
Bass Control Range (@ 100 Hz):	± 12 dB (in 2 dB steps)
Treble Control Range (@ 10 kHz):	± 12 dB (in 2 dB steps)

VIDEO

Input/Output Impedance:	75 Ohms
Video Insertion Loss:	< 1.0 dB (50 Hz to 10 MHz)

GENERAL

RC68 Code Group Number assigned to the ZPR68-10	68
Control (CO) & STATUS Outputs	12 V @ 10 mA, 9 V @ 90 mA (90 mA is max. current)
Max. Total Current Available From +12V, STATUS & CO Terminals	1.8 A
Power Requirements:	14V-0-14V AC @ 2.7 A, 8V-0-8V AC @ 0.7 A (Multi-Voltage Power supply included)
Gold Plated RCA type phono jacks	All A/V inputs/outputs
Dimensions:	14" W x 7" H x 2.5" D
Weight:	4 lbs, 3 oz.

Note: *VC = Volume Control setting

ZPR68-10 BLOCK DIAGRAM

